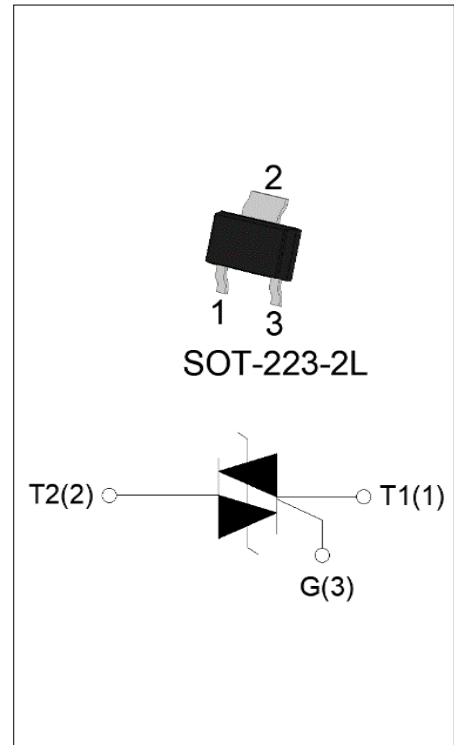

ACJT105-10W 1A TRIAC

Rev.A.1.0

DESCRIPTION:

The ACJT105-10W triac is suitable for general purpose AC switching. It can be used as an ON/OFF function in applications such as heating regulation, induction motor starting circuits, for phase control operation in light dimmers, motor speed controllers. The ACJT105-10W embeds a TVS structure to absorb the inductive turn-off energy such as those described in the IEC 61000-4-5 standards. Package SOT-223-2L is RoHS compliant.

MAIN FEATURES

Symbol	Value	Unit
$I_{T(RMS)}$	1	A
V_{DRM}/V_{RRM}	1000	V
$I_{GT\ I/II/III}$	5/5/5	mA

ABSOLUTE MAXIMUM RATINGS

Parameter	Symbol	Value	Unit
Storage junction temperature range	T_{stg}	-40-150	°C
Operating junction temperature range	T_j	-40-125	°C
Repetitive peak off-state voltage ($T_j=25^\circ\text{C}$)	V_{DRM}	1000	V
Repetitive peak reverse voltage ($T_j=25^\circ\text{C}$)	V_{RRM}	1000	V
RMS on-state current ($T_c \leq 90^\circ\text{C}$)	$I_{T(RMS)}$	1	A
Non repetitive surge peak on-state current (full cycle , $t_p=20\text{ms}$, $T_j=25^\circ\text{C}$)	I_{TSM}	15	A
Non repetitive surge peak on-state current (full cycle , $t_p=16.6\text{ms}$, $T_j=25^\circ\text{C}$)		16.5	
I^2t value for fusing ($t_p=10\text{ms}$, $T_j=25^\circ\text{C}$)	I^2t	1.25	A^2s
Critical rate of rise of on-state current ($I_G=2 \times I_{GT}$, $f=100\text{Hz}$, $T_j=125^\circ\text{C}$)	di/dt	50	$\text{A}/\mu\text{s}$
Peak gate current ($t_p=20\mu\text{s}$, $T_j=125^\circ\text{C}$)	I_{GM}	2	A
Average gate power dissipation ($T_j=125^\circ\text{C}$)	$P_{G(AV)}$	0.1	W
Peak gate power	P_{GM}	5	W

Peak pulse voltage ($T_j=25^\circ\text{C}$; non-repetitive, off-state; FIG.8)	V_{pp}	3.5	kV
--	----------	-----	----

ELECTRICAL CHARACTERISTICS ($T_j=25^\circ\text{C}$ unless otherwise specified)

Symbol	Test Condition	Quadrant	Value		Unit
I_{GT}	$V_D=12\text{V}$ $R_L=33\Omega$	I - II - III	MAX.	5	mA
V_{GT}		I - II - III	MAX.	1	V
V_{GD}	$V_D=V_{DRM}$ $T_j=125^\circ\text{C}$ $R_L=3.3\text{K}\Omega$	I - II - III	MIN.	0.2	V
I_L	$I_G=1.2I_{GT}$	I - III	MAX.	10	mA
		II		20	
I_H	$I_T=100\text{mA}$		MAX.	10	mA
dV/dt	$V_D=670\text{V}$ Gate Open $T_j=125^\circ\text{C}$		MIN.	500	V/ μs
$(dI/dt)_c$	$(dV/dt)_c=10\text{V}/\mu\text{s}$, $T_j=125^\circ\text{C}$		MIN.	0.5	A/ms
t_{on}	$I_G=10\text{mA}$ $I_A=200\text{mA}$ $I_R=20\text{mA}$ $T_j=25^\circ\text{C}$		TYP.	2.5	μs
t_{off}				35	
V_{CL}	$I_{CL}=0.1\text{mA}$ $t_p=1\text{ms}$		MIN.	1050	V

STATIC CHARACTERISTICS

Symbol	Parameter		Value(MAX.)	Unit
V_{TM}	$I_{TM}=1.1\text{A}$ $t_p=380\mu\text{s}$	$T_j=25^\circ\text{C}$	1.4	V
V_{TO}	Threshold voltage	$T_j=125^\circ\text{C}$	0.8	V
R_D	Dynamic resistance	$T_j=125^\circ\text{C}$	287	$\text{m}\Omega$
I_{DRM}	$V_D=V_{DRM}$ $V_R=V_{RRM}$	$T_j=25^\circ\text{C}$	8	μA
I_{RRM}		$T_j=125^\circ\text{C}$	0.4	mA

THERMAL RESISTANCES

Symbol	Parameter	Value	Unit
$R_{th(j-c)}$	junction to case (AC)	25	$^\circ\text{C}/\text{W}$
$R_{th(j-a)}$	junction to ambient (AC)	140	$^\circ\text{C}/\text{W}$

ORDERING INFORMATION

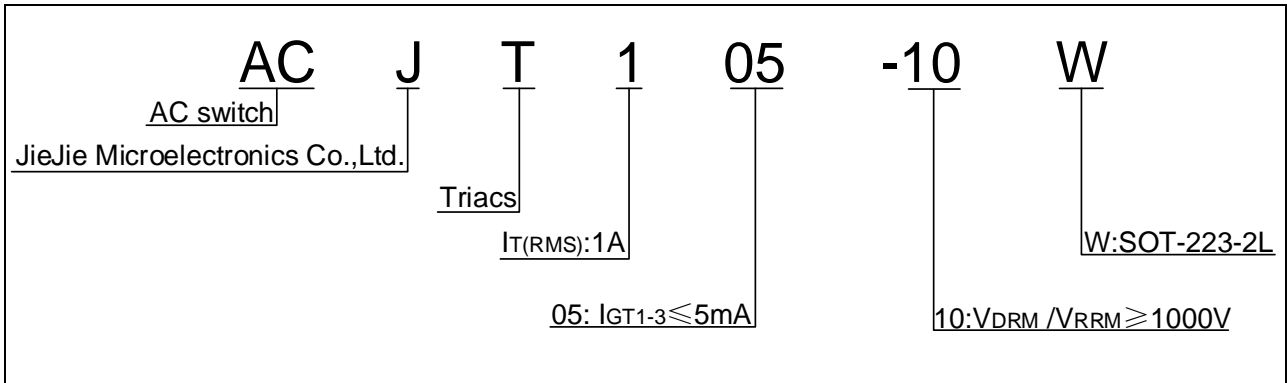

MARKING

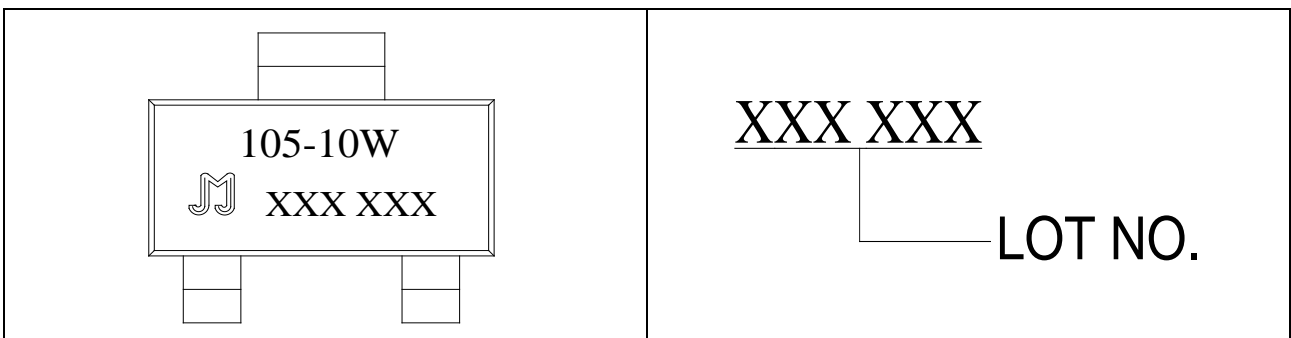

FIG.1 Maximum power dissipation versus RMS on-state current

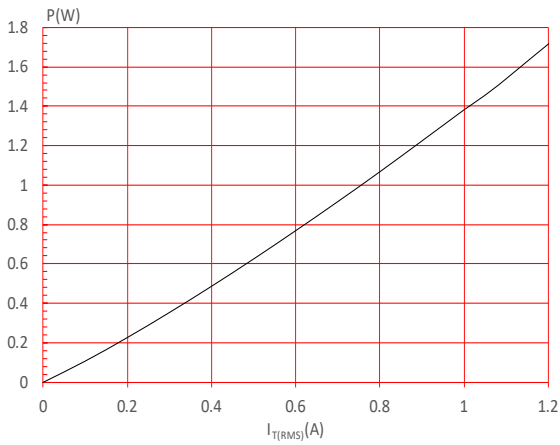

FIG.2: RMS on-state current versus case temperature

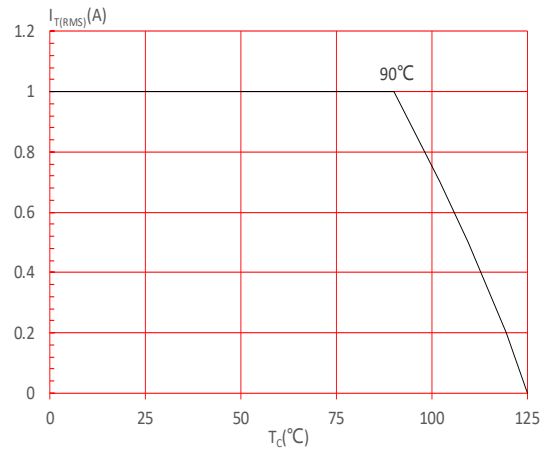

FIG.3: RMS on-state current versus ambient temperature (printed circuit board FR4,copper thickness:35μm)(full cycle)

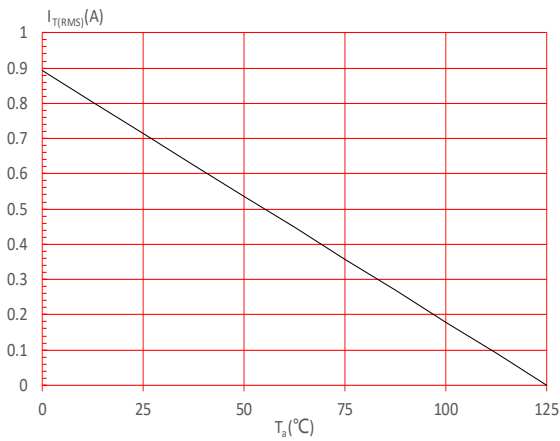

FIG.4: Surge peak on-state current versus number of cycles

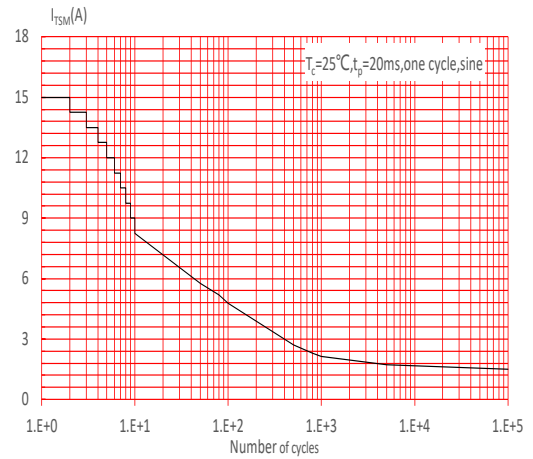

FIG.5: On-state characteristics

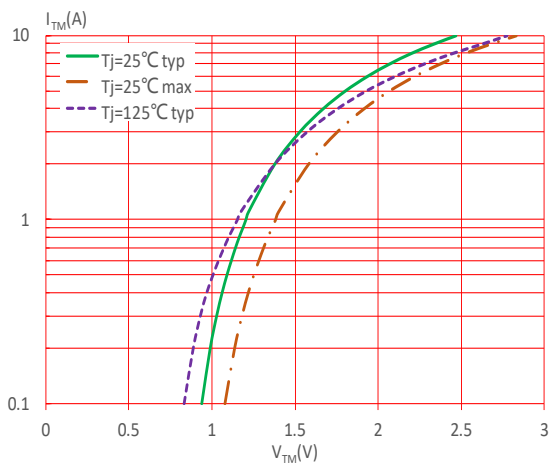

FIG.6: Non-repetitive surge peak on-state current for a sinusoidal pulse with width $t_p < 20\text{ms}$, and corresponding value of I^2t ($di/dt < 50\text{A}/\mu\text{s}$)

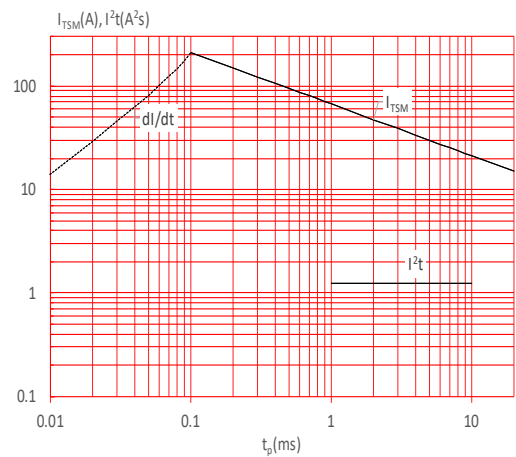

FIG.7: Relative variations of gate trigger current, holding current and latching current versus junction temperature

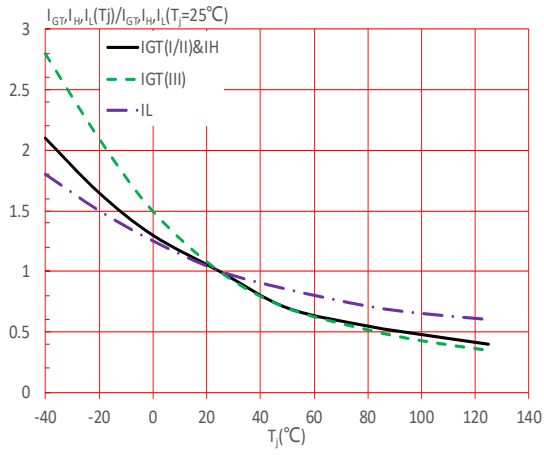
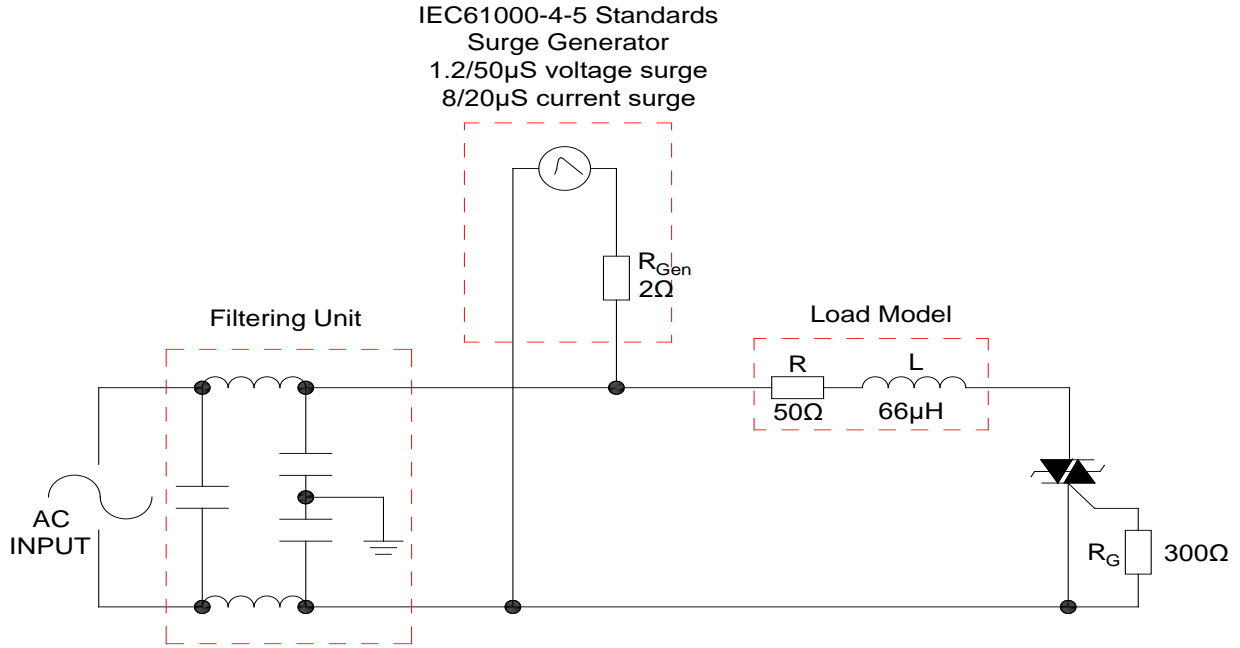
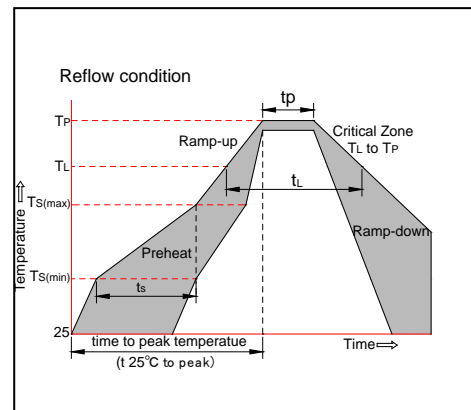

FIG.8: Test circuit for inductive and resistive loads to IEC-61000-4-5 standards



SOLDERING PARAMETERS

Reflow Condition		Pb-Free assembly (see figure at right)
Pre Heat	-Temperature Min ($T_{s(min)}$)	+150°C
	-Temperature Max($T_{s(max)}$)	+200°C
	-Time (Min to Max) (ts)	60-180 secs.
Average ramp up rate (Liquidus Temp (T_L) to peak)		3°C/sec. Max
$T_{s(max)}$ to T_L - Ramp-up Rate		3°C/sec. Max
Reflow	-Temperature(T_L)(Liquidus)	+217°C
	-Temperature(t_L)	60-150 secs.
Peak Temp (T_p)		+260(+0/-5)°C
Time within 5°C of actual Peak Temp (t_p)		20-40secs.
Ramp-down Rate		6°C/sec. Max
Time 25°C to Peak Temp (T_p)		8 min. Max
Do not exceed		+260°C



ORDERING INFORMATION

Order code	Voltage V_{DRM}/V_{RRM} (V)	IGT(mA)	Package	Base qty. (pcs)	Delivery mode
ACJT105-10W	1000	5	SOT-223-2L	4,000	Tape & Reel

Document Revision History

Date	Revision	Changes
Apr.13, 2023	A.1.0	Last updated

PACKAGE MECHANICAL DATA

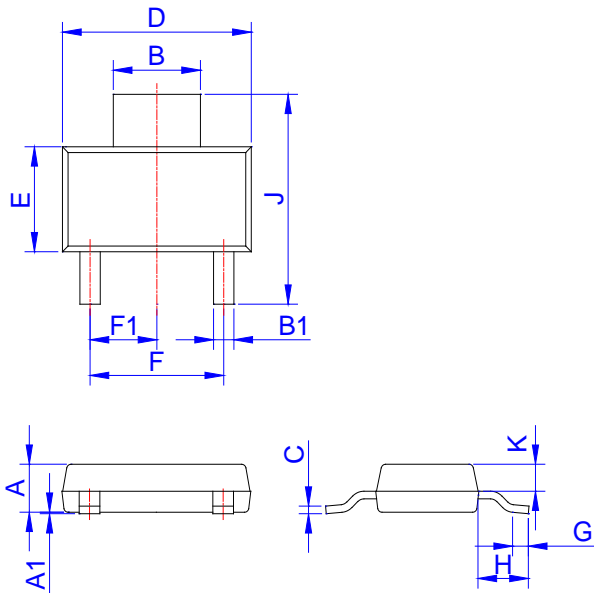

Ref.	Dimensions					
	Millimeters			Inches		
	Min.	Typ.	Max.	Min.	Typ.	Max.
A	1.50	1.60	1.80	0.059	0.063	0.071
A1	0.01	0.06	0.10	0.001	0.002	0.004
B	2.90	3.00	3.10	0.114	0.118	0.122
B1	0.60	0.70	0.80	0.024	0.028	0.031
C	0.22	0.254	0.32	0.009	0.010	0.013
D	6.30	6.50	6.70	0.248	0.256	0.264
E	3.30	3.50	3.70	0.130	0.138	0.146
F	4.40		4.80	0.173		0.189
F1	2.20		2.40	0.087		0.094
G	0.50		1.00	0.020		0.039
H	1.50	1.75	2.00	0.059	0.069	0.079
J	6.70	7.00	7.30	0.264	0.276	0.287
K	0.80		1.00	0.031		0.039

FOOTPRINT-SOT-223-2L (dimensions in mm)

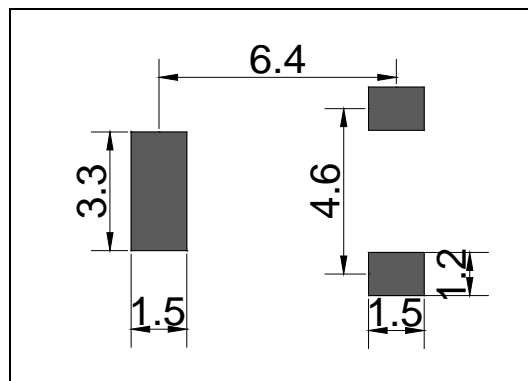

DELIVERY MODE

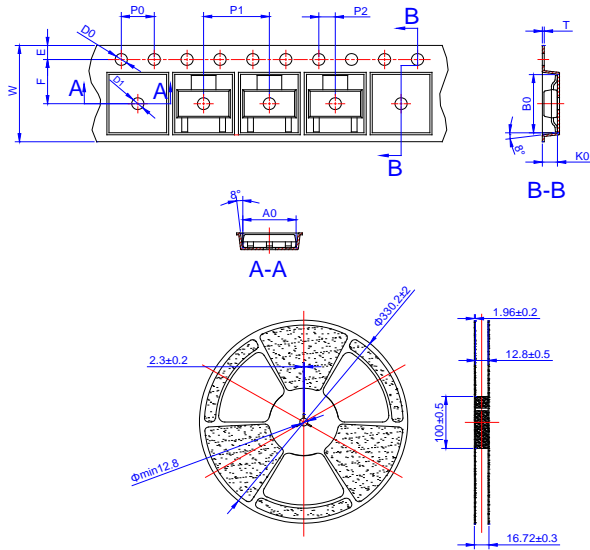

Ref.	Dimensions					
	Millimeters			Inches		
	Min.	Typ.	Max.	Min.	Typ.	Max.
W	-	-	12.30	-	-	0.482
E	1.65	1.75	1.85	0.065	0.069	0.073
F	5.45	5.50	5.55	0.215	0.217	0.219
D0	1.50	1.55	1.60	0.059	0.061	0.063
D1	1.50	-	-	0.059	-	-
P0	3.90	4.00	4.10	0.154	0.157	0.161
P1	7.90	8.00	8.10	0.311	0.315	0.319
P2	1.95	2.00	2.05	0.077	0.079	0.081
10P0	39.80	40.00	40.20	1.567	1.575	1.583
A0	6.85	6.95	7.05	0.269	0.273	0.276
B0	7.15	7.25	7.35	0.280	0.284	0.288
K0	1.95	2.05	2.15	0.076	0.080	0.084
T	0.20	0.25	0.30	0.008	0.010	0.012

PACKAGE	OUTLINE	REEL (PCS)	PER CARTON (PCS)	TAPE & REEL
SOT-223-2L	TAPING	4,000	40,000	13 inch

Information furnished in this document is believed to be accurate and reliable. However, Jiangsu JieJie Microelectronics Co., Ltd. assumes no responsibility for the consequences of use without consideration for such information nor use beyond it. Information mentioned in this document is subject to change without notice, apart from that when an agreement is signed, Jiangsu JieJie complies with the agreement.

Products and information provided in this document have no infringement of patents. Jiangsu JieJie assumes no responsibility for any infringement of other rights of third parties which may result from the use of such products and information. This document supersedes and replaces all information previously supplied.

 is a registered trademark of Jiangsu JieJie Microelectronics Co., Ltd.
Copyright ©2023 Jiangsu JieJie Microelectronics Co., Ltd. All rights reserved.